

Dual Modular Safety Shutoff Valves with Proof of Closure Option

DMV eco Series
DMV-D eco Series
DMV-DLE eco Series

DUNGS[®]
Combustion Controls



Two normally closed safety shutoff valves in one housing; each with the following approvals.

CSA Certified

- ANSI Z21.21 / CSA 6.5
- Marked C/I
- File # 157406

FM Approved

- Class 7411
- File # 3047863

Commonwealth of Massachusetts Approved Product

- Approval code G1-1107-35
- Gas Safety Shutoff Valve

EU Gas Appliance Directive

- EN161
- CE-0085AN2801

AGA (Australian Gas Association)

- AS 4629
- Class 1
- File # 5038

Codes and Standards

This product is intended for installations covered by but not limited to NFPA 37, NFPA 85, NFPA 86, CSA B149.1, CSA B149.3 and CSA 149.6.

DUNGS is an ISO 9001 manufacturing facility.



Description

The DUNGS Dual Modular Valve (DMV) eco combines two safety shutoff valves in one compact housing, with an option for Proof of Closure on valve two or both valves.

Valve 1 (V1) of the DMV, DMV-D and DMV-DLE series is fast opening and fast closing. Valve 2 (V2) of the DMV-D is fast opening, while V2 of the DMV-DLE is slow-opening for smoother light-off. Max. flow adjustment on V1 provides variable main flow on both models.

Internal profiles and compact design optimize flow and provide a low pressure drop.

Directly mounting the following DUNGS accessories creates a compact valve train without additional piping:

- High and low gas pressure switches
- Valve proving system
- 1" NPT Vent line adapter

Application

The DUNGS DMV eco is recommended for industrial and commercial heating applications that require two safety shutoff valves with or without Proof of Closure. The DMV eco is suitable for dry natural gas, propane, butane, air and other inert gases. Suitable for up to 0.1% by volume, dry H₂S.

A "dry" gas has a dew point lower than +15 °F and its relative humidity is less than 60 %.

Viton versions available and suitable for up to 1 % H₂S and 100 % Humidity.

Specification

DMV	Two normally closed safety shutoff valves in one housing. V1 and V2 are fast opening, fast closing.
DMV-D	Two normally closed safety shutoff valves in one housing. V1 and V2 are fast opening, fast closing. Adjustable max. flow on V1.
DMV-DLE	Two normally closed safety shutoff valves in one housing. V1 fast opening, fast closing. V2 slow opening, fast closing valve. Adjustable max. flow V1 and adjustable initial lift with V2.
DMV-D(LE) /60x	Does not include any Proof Of Closure
DMV-D(LE) /62x	Includes Proof of Closure on V2
DMV-D(LE) /63x	Includes Proof of Closure both on V1 and V2

Specifications

Flange sizes	65 (2 1/2") 80 (3") 100 (4") 125 (5") Connection flange as per DIN 2501 Part 1, to fit pre-weld flanges as per DIN 2633 (PN 16) DN 125, ISO 7005 - 1 (PN 16), or ISO 7005 - 2 (PN 16). Raised Face.
Max. operating pressure	7 PSI (500 mbar)
Max. body pressure	15 PSI (1000 mbar)
Max. close off pressure	7 PSI (500 mbar)
Electrical ratings (+10 % / -15 %)	110 - 120 VAC @ 50 - 60 Hz and 24 VDC. Part numbers listed on page 3. 220 - 240 VAC @ 50 - 60 Hz (P/N on request)
Enclosure rating	NEMA Type 12 (NEMA Type 4 optional)
Electrical connection	DIN-connector with 1/2" NPT conduit adapter (order separately)
Operating time	100 % duty cycle
Closing time	< 1 s
Opening time (to max. flow)	DMV-... V1 & V2 < 1 s DMV-D... V1 & V2 < 1 s DMV-DLE... V1 < 1 s; V2 Adjustable to approx. 10 to 20 s at 70 °F
Initial lift adjustment	Adjustable on V2 DLE only; 0 to 70 % of total flow; 0 to 25% of stroke Not available on 24 VDC Versions.
Max. flow adjustment	Adjustable on V1 <10 to 100 % of total flow; <10 to 100% of stroke Not available on 24 VDC Versions.
Materials in contact with gas	Housing: Aluminium, Steel; free of non-ferrous metals Sealings on valve seats: NBR-based rubber. Versions with FKM/Viton available for corrosive gases.
Ambient temperature rating	+5 °F to +140 °F (-15 °C to +60 °C) NBR Versions +32 °F to +140 °F (0 °C to +60 °C) Viton Versions
Installation position	Safety shut off valve from vertically upright to horizontal
Gas strainer (standard)	Installed in the housing upstream V1 (23 mesh)
Proof of Closure option	CPI 400 valve switch with indication lamps and SPDT interlock switch
Test ports / Pressure switch mounting ports	G 1/8 ISO 228 ports available on both sides. Each side has two ports upstream V1, one between V1 and V2, one downstream V2. G 1/4 ISO 228 on both flanges, upstream of V1, downstream of V2 G 3/4" Port upstream V1 each side of the valve
Position indication option	Visual Indicator (VI) to show valve position
Valve proving system	VPS 504; mounts directly to either side of DMV
Vent line adapter	1" NPT Field mountable

Power Consumption with all coils energized (24 VDC/120 VAC & 230 VAC)

	Inrush (VA)	Operation (VA)
DMV-D(LE) 5065/11 eco 6xx	130 VA	32 VA
DMV-D(LE) 5080/11 eco 6xx	190 VA	40 VA
DMV-D(LE) 5100/11 eco 6xx	250 VA	50 VA
DMV-D(LE) 5125/11 eco 6xx	250 VA	50 VA

Dimensions inch (mm)

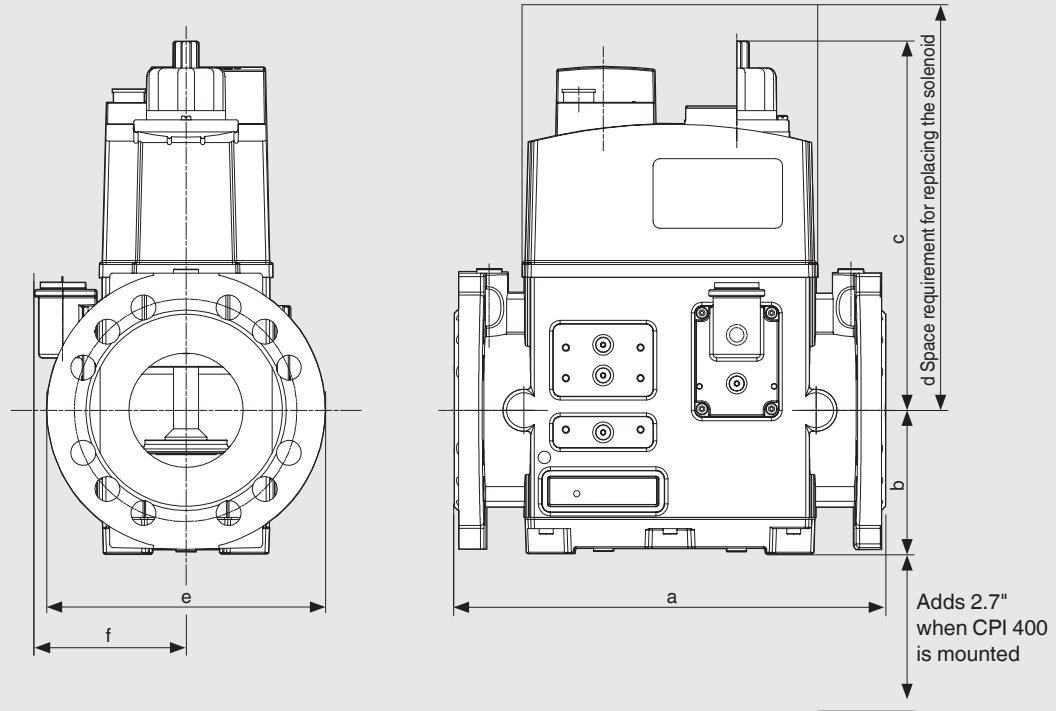

Type	Connection DN	Dimensions [inch] Dimensions [mm]						Weight [lbs] [kg]
		a	b	c	d	e	f	
DMV 5065/6xx eco	DN 65 (2 1/2")	11.4	3.5	7.0	10.8	7.3	3.8	22.0
		290	88	179	275	185	97	10,0
DMV 5080/6xx eco	DN 80 (3")	12.2	4.1	9.7	14.6	7.9	4.3	35.9
		310	104	246	370	200	109	16,3
DMV 5100/6xx eco	DN 100 (4")	13.8	4.7	14.5	17.7	8.7	4.6	53.4
		350	119	292	450	220	116	24,2
DMV 5125/6xx eco	DN 125 (5")	15.7	5.6	13.0	19.7	10.0	4.9	69.9
		400	142	329	500	255	125	31,7
DMV-D 5065/6xx eco	DN 65 (2 1/2")	11.4	3.5	7.0	10.8	7.3	3.8	22.0
		290	88	179	275	185	97	10,0
DMV-D 5080/6xx eco	DN 80 (3")	12.2	4.1	9.7	14.6	7.9	4.3	35.9
		310	104	246	370	200	109	16,3
DMV-D 5100/6xx eco	DN 100 (4")	13.8	4.7	14.5	17.7	8.7	4.6	53.4
		350	119	292	450	220	116	24,2
DMV-D 5125/6xx eco	DN 125 (5")	15.7	5.6	13.0	19.7	10.0	4.9	69.9
		400	142	329	500	255	125	31,7
DMV-DLE 5065/6xx eco	DN 65 (2 1/2")	11.4	3.5	7.0	10.8	7.3	3.8	22.0
		290	88	179	275	185	97	10,0
DMV-DLE 5080/6xx eco	DN 80 (3")	12.2	4.1	10.4	14.6	7.9	4.3	36.4
		310	104	265	370	200	109	16,5
DMV-DLE 5100/6xx eco	DN 100 (4")	13.8	4.7	13.6	17.7	8.7	4.6	54.0
		350	119	346	450	220	116	24,5
DMV-DLE 5125/6xx eco	DN 125 (5")	15.7	5.6	15.2	19.7	10.0	4.9	70.6
		400	142	387	500	255	125	32,0

Valve Type	Pipe Size	Coil No.	Valve Seat Material	Voltage	NEMA Type	Proof of Closure	Order No.
DMV 5065/602 eco	DN 65 (2 1/2")	1411/2P	NBR	110 VAC	12	no	267158
DMV-DLE5065/602 eco	DN 65 (2 1/2")	1411/2PL	NBR	110 VAC	12	no	267162
DMV 5065/622 eco	DN 65 (2 1/2")	1411/2P	NBR	110 VAC	12	V2	269335
DMV-DLE5065/622 eco	DN 65 (2 1/2")	1411/2PL	NBR	110 VAC	12	V2	269337
DMV 5065/632 eco	DN 65 (2 1/2")	1411/2P	NBR	110 VAC	12	V1 & V2	269336
DMV-DLE5065/632 eco	DN 65 (2 1/2")	1411/2PL	NBR	110 VAC	12	V1 & V2	267163
DMV 5065/602 eco	DN 65 (2 1/2")	1411/2P	NBR	24 VDC	12	no	267164
DMV 5065/622 eco	DN 65 (2 1/2")	1411/2P	NBR	24 VDC	12	V2	269338
DMV 5065/632 eco	DN 65 (2 1/2")	1411/2P	NBR	24 VDC	12	V1 & V2	269339
DMV 5080/602 eco	DN 80 (3")	1511/2P	NBR	110 VAC	12	no	267154
DMV-DLE5080/602 eco	DN 80 (3")	1511/2PL	NBR	110 VAC	12	no	267165
DMV 5080/622 eco	DN 80 (3")	1511/2P	NBR	110 VAC	12	V2	269330
DMV-DLE5080/622 eco	DN 80 (3")	1511/2PL	NBR	110 VAC	12	V2	269340
DMV 5080/632 eco	DN 80 (3")	1511/2P	NBR	110 VAC	12	V1 & V2	267155
DMV-DLE5080/632 eco	DN 80 (3")	1511/2PL	NBR	110 VAC	12	V1 & V2	269341
DMV 5080/602 eco	DN 80 (3")	1511/2P	NBR	24 VDC	12	no	267166
DMV 5080/622 eco	DN 80 (3")	1511/2P	NBR	24 VDC	12	V2	267167
DMV 5080/632 eco	DN 80 (3")	1511/2P	NBR	24 VDC	12	V1 & V2	269342
DMV 5100/602 eco	DN 100 (4")	1611/2P	NBR	110 VAC	12	no	267157
DMV-DLE5100/602 eco	DN 100 (4")	1611/2PL	NBR	110 VAC	12	no	269343
DMV 5100/622 eco	DN 100 (4")	1611/2P	NBR	110 VAC	12	V2	269333
DMV-DLE5100/622 eco	DN 100 (4")	1611/2PL	NBR	110 VAC	12	V2	269344
DMV 5100/632 eco	DN 100 (4")	1611/2P	NBR	110 VAC	12	V1 & V2	269334
DMV-DLE5100/632 eco	DN 100 (4")	1611/2PL	NBR	110 VAC	12	V1 & V2	269345
DMV 5100/602 eco	DN 100 (4")	1611/2P	NBR	24 VDC	12	no	267168
DMV 5100/622 eco	DN 100 (4")	1611/2P	NBR	24 VDC	12	V2	269346
DMV 5100/632 eco	DN 100 (4")	1611/2P	NBR	24 VDC	12	V1 & V2	269347
DMV 5125/602 eco	DN 125 (5")	1711/2P	NBR	110 VAC	12	no	267156
DMV-DLE5125/602 eco	DN 125 (5")	1711/2PL	NBR	110 VAC	12	no	269348
DMV 5125/622 eco	DN 125 (5")	1711/2P	NBR	110 VAC	12	V2	269331
DMV-DLE5125/622 eco	DN 125 (5")	1711/2PL	NBR	110 VAC	12	V2	269349
DMV 5125/632 eco	DN 125 (5")	1711/2P	NBR	110 VAC	12	V1 & V2	269332
DMV-DLE5125/632 eco	DN 125 (5")	1711/2PL	NBR	110 VAC	12	V1 & V2	269350
DMV 5125/602 eco	DN 125 (5")	1711/2P	NBR	24 VDC	12	no	267169
DMV 5125/622 eco	DN 125 (5")	1711/2P	NBR	24 VDC	12	V2	269351
DMV 5125/632 eco	DN 125 (5")	1711/2P	NBR	24 VDC	12	V1 & V2	267170

Valve Type	Pipe Size	Coil No.	Valve Seat Material	Voltage	NEMA Type	Proof of Closure	Order No.
DMV 5065/624 eco	DN 65 (2 1/2")	1411/2P-4	NBR	110 VAC	4	V2	269397
DMV-DLE5065/624 eco	DN 65 (2 1/2")	1411/2PL-4	NBR	110 VAC	4	V2	269400
DMV 5065/634 eco	DN 65 (2 1/2")	1411/2P-4	NBR	110 VAC	4	V1 & V2	269398
DMV-DLE5065/634 eco	DN 65 (2 1/2")	1411/2PL-4	NBR	110 VAC	4	V1 & V2	269401
DMV 5080/624 eco	DN 80 (3")	1511/2P-4	NBR	110 VAC	4	V2	269387
DMV-DLE5080/624 eco	DN 80 (3")	1511/2PL-4	NBR	110 VAC	4	V2	268488
DMV 5080/634 eco	DN 80 (3")	1511/2P-4	NBR	110 VAC	4	V1 & V2	269388
DMV-DLE5080/634 eco	DN 80 (3")	1511/2PL-4	NBR	110 VAC	4	V1 & V2	269403
DMV-5100/624 eco	DN 100 (4")	1611/2P-4	NBR	110 VAC	4	V2	269394
DMV-DLE5100/624 eco	DN 100 (4")	1611/2PL-4	NBR	110 VAC	4	V2	269408
DMV 5100/634 eco	DN 100 (4")	1611/2P-4	NBR	110 VAC	4	V1 & V2	269395
DMV-DLE5100/634 eco	DN 100 (4")	1611/2PL-4	NBR	110 VAC	4	V1 & V2	269409
DMV 5125/624 eco	DN 125 (5")	1711/2P-4	NBR	110 VAC	4	V2	269390
DMV-DLE5125/624 eco	DN 125 (5")	1711/2PL-4	NBR	110 VAC	4	V2	269414
DMV 5125/634 eco	DN 125 (5")	1711/2P-4	NBR	110 VAC	4	V1 & V2	269391
DMV-DLE5125/634 eco	DN 125 (5")	1711/2PL-4	NBR	110 VAC	4	V1 & V2	269415

Note: Viton versions available upon request

Valve Type	Pipe Size	Coil No.	Valve Seat Material	Voltage	NEMA Type	Proof of Closure	Order No.
DMV 5080/602 eco	DN 80 (3")	1511/2P	Viton	24 VDC	12	no	267171
DMV-5080/622 eco	DN 80 (3")	1511/2P	Viton	24 VDC	12	V2	269352
DMV-5080/632 eco	DN 80 (3")	1511/2P	Viton	24 VDC	12	V1 & V2	269353
DMV-5100/602 eco	DN 100 (4")	1611/2P	Viton	24 VDC	12	no	267172
DMV-5100/622 eco	DN 100 (4")	1611/2P	Viton	24 VDC	12	V2	269354
DMV-5100/632 eco	DN 100 (4")	1611/2P	Viton	24 VDC	12	V1 & V2	269355
DMV-5125/602 eco	DN 125 (5")	1711/2P	Viton	24 VDC	12	no	267173
DMV-5125/622 eco	DN 125 (5")	1711/2P	Viton	24 VDC	12	V2	269356
DMV-5125/632 eco	DN 125 (5")	1711/2P	Viton	24 VDC	12	V1 & V2	269357

Equipment variants of DMV double solenoid valve, single-stage mode	DMV 5065 - DMV 5125
DMV & DMV-D*	X
DMV-DLE*	X
Strainer	X
Gas pressure switch can be mounted: on flange	X
downstream of sieve	Possible using a pipe nipple (X)
downstream of valve 2	(X)
Valve V1, double-seat	X
Valve V2, double-seat	X
Valves opening separately	X
G 3/4 ignition gas flange can be mounted	(X)
1" Vent line adapter	(X)

X	standard
(X)	on request
-	not possible

* not available in 24 VDC

DMV Flange Accessories						
Body Size	Flange Description (Raised Face)	# of Holes per Flange	Flange Order No.	Stud size	**Stud Order No.	***Gasket Order No.
DN 65	2 1/2" ISO Flanged	4	227139	M16x65	135930	267464
DN 65	2 1/2" ISO to NPT	4	243690	M16x65	135930	267464
DN 80	3" ISO Flanged	8	227140	M16x65	135930	267466
DN 80	3" ISO to NPT	8	243219	M16x65	135930	267466
DN 100	4" ISO Flanged	8	227141	M16x65	135930	267467
DN 125	5" ISO Flanged	8	227142	M16x75	148830	267468

* When a control is used alone, one mating flange is needed for each end, for a total of two flanges. When one control is bolted to another, such as an FRS to a DMV dual modular safety valve, one mating flange is needed for each end, for a total of two flanges.

** Includes one stud, two lock washers, and two nuts.

*** One seal needed for each flange.

Dual Modular Valve (DMV) system

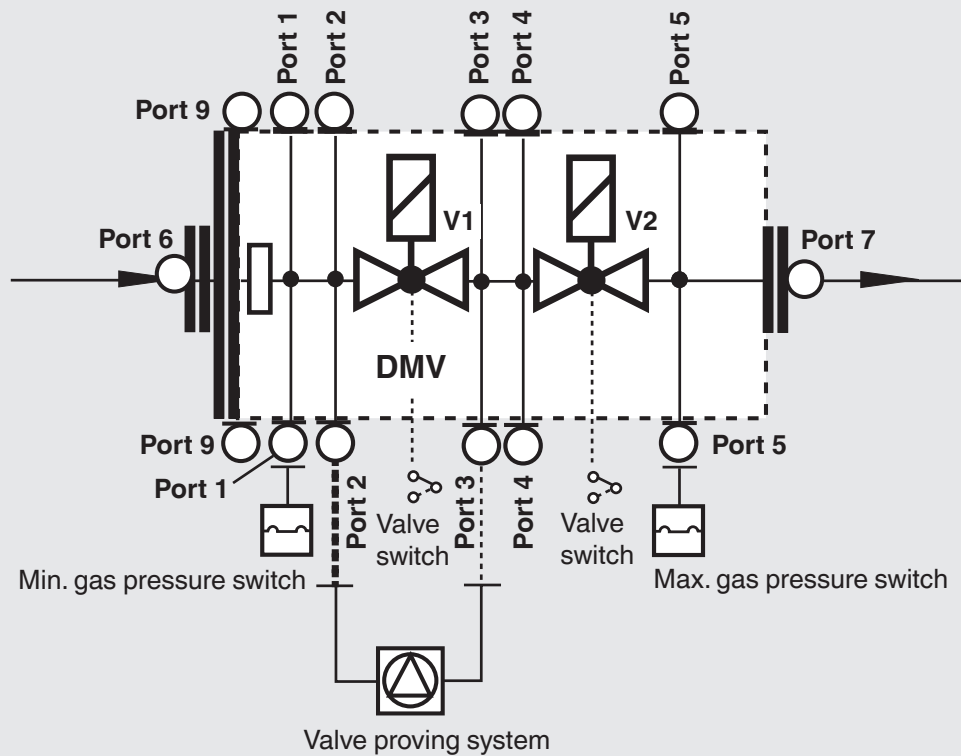

Additional Accessories

VPS 504

Valve proving system (approved by some authorities having jurisdiction in lieu of vent valve and “proof of closure” (e.g. FM, NFPA 85, NFPA 86, CSA B149.3 and XL GAP).

GAO/GMH/GML A2 pressure switch

Position indication

CPI 400 with indication lamps and **SPDT** interlock switch, or Visual indicator (VI)

DMK butterfly control valve

Mounts directly downstream of DMV to modulate gas flow. Requires actuator. Use DMA actuator with DMK butterfly valve.

Adapters

- 1/4" NPT adapter (225047)
- 1/2" NPT Pilot gas adapter; Check flow requirements. (225043)
- G 1/8" Test nipple (219008)
- 1" NPT Vent line adapter (can be used as pilot take-off upstream V2) (243760)
- 3/4" Pilot take-off available upstream V2.

Pressure drop for other gases

To determine the pressure drop when using a gas other than natural gas, use the flow formula below and f value located in the table below to determine

the “corrected” flow rate in CFH through the valve for the other gas used. For example, when using propane, divide the volume (CFH) of propane required for the application by the calculated value

f (f = 0.66 for propane). Use this “corrected” flow rate and the flow curve on the next page to determine pressure drop for propane.

Determining equivalent flow through valves using another gas

$$\dot{V}_{\text{gas used}} = \dot{V}_{\text{Natural gas}} \times f$$

$$f = \sqrt{\frac{\text{Density of Natural gas}}{\text{Density of gas used}}}$$

Type of gas	Density [kg/m ³]	s.g.	f
Natural gas	0.81	0.65	1.00
Butane	2.39	1.95	0.58
Propane	1.86	1.50	0.66
Air	1.24	1.00	0.80

**Dual Modular Safety
Shutoff Valves with
Proof of Closure Option**

**DMV eco Series
DMV-D eco Series
DMV-DLE eco Series**



Flow curve

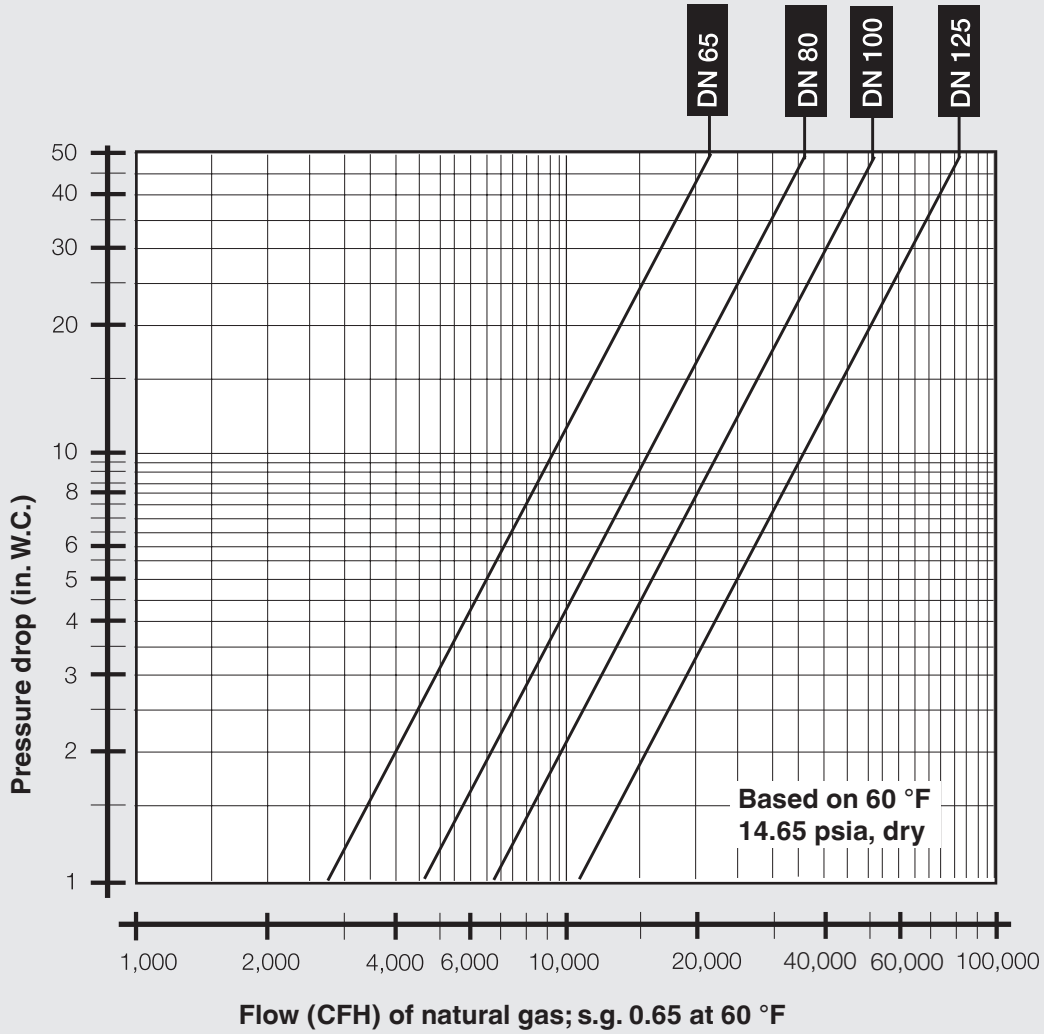

We reserve the right to make any changes in the interest of technical progress.

Karl Dungs, Inc.
3890 Pheasant Ridge Drive NE
Suite 150
Blaine, MN 55449, U.S.A.
Phone 763 582-1700
Fax 763 582-1799
e-mail info@karldungsusa.com
Internet <http://www.dungs.com/usa/>

Karl Dungs GmbH & Co. KG
P.O. Box 12 29
D-73602 Schorndorf, Germany
Phone +49 (0)7181-804-0
Fax +49 (0)7181-804-166
e-mail info@dungs.com
Internet <http://www.dungs.com>